

A-A  
1:2

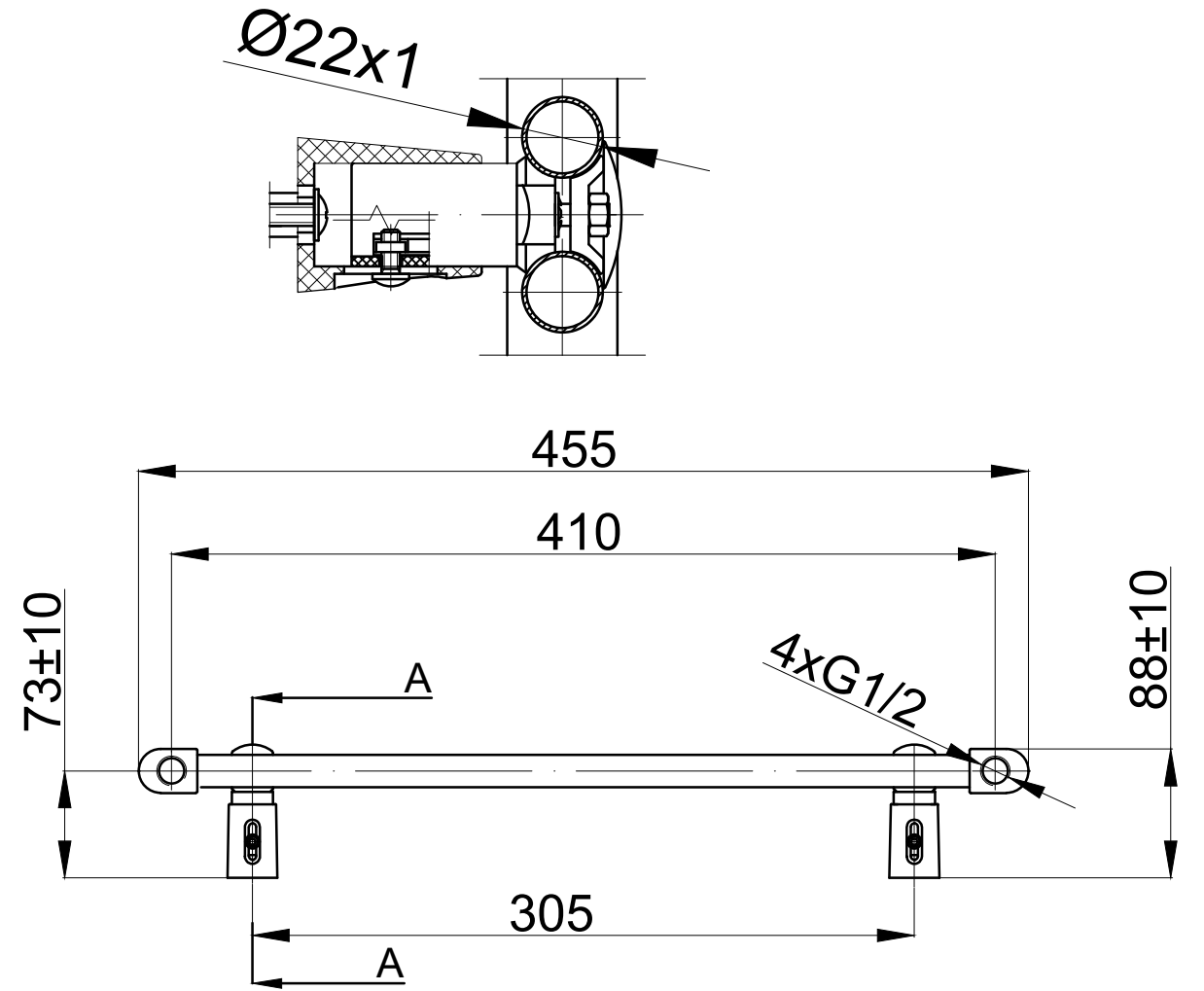

ILR64E